

# HIVE



## Hive Thermostat



# Welcome to your Hive Thermostat

Your Hive Thermostat is the clever way to control your heating, and if you have a hot water tank, your hot water too. This guide tells you everything you need to know.

## Contents

① Heating	page 4
② Hot water	page 6
③ Other features	page 9
④ Hive Multizone	page 9
⑤ Troubleshooting	page 10

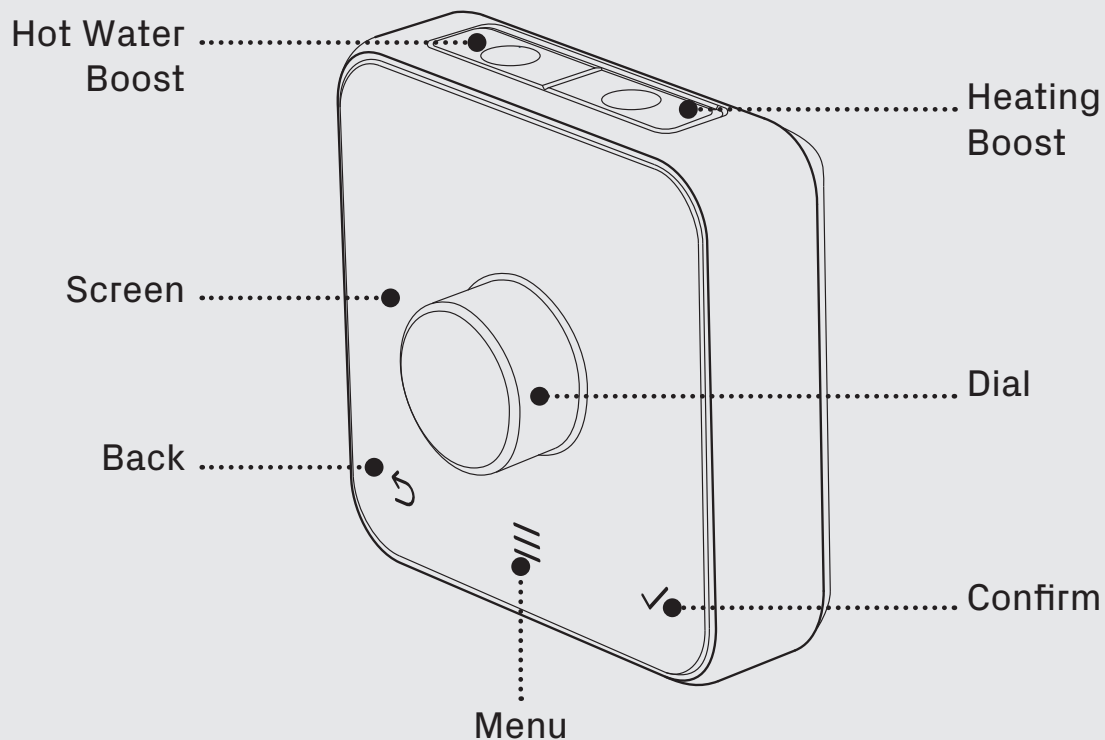

**Hot tip:** For help controlling your heating and hot water remotely visit [hivehome.com](https://hivehome.com)

### Getting started

#### How to change the temperature:

- 1 Turn the dial clockwise to increase the target temperature
- 2 Your heating will come on if the target temperature is above the actual temperature (you'll see  when the heating is on)
- 3 Turn the dial anti-clockwise to lower the target temperature



# 1 Heating

## How to change mode:

Your thermostat has 3 different heating modes: **Schedule**, **Manual** and **Off**:

- 1 Push the dial to wake up the thermostat
- 2 Once the screen turns on, press the **Menu**  button and select **Heat**
- 3 Here you'll see the different modes: **Schedule**, **Manual** and **Off**
- 4 Select one by turning and pushing the dial

**Schedule** allows your heating to turn on and off based on occupancy and can reduce energy consumption

**Manual** makes sure your home maintains a constant temperature

**Off** leaves your heating in Frost Protection – so your heating will only come on if your home drops below 7 °C. You'll see ❄️ on the screen to remind you that Frost Protection is enabled.

## Setting up a heating schedule:

Your thermostat will walk you through setting up your heating schedule step by step.

### To do this:

- 1 Wake up your thermostat by pushing the dial and then press the **Menu**  button
- 2 Turn the dial to select **Heat** and push the dial to confirm
- 3 Select **Schedule** and push the dial to confirm
- 4 Scroll to **Start Over** and push the dial to confirm
- 5 Follow the on-screen instructions to create your new schedule

### How to view your heating schedule:

- 1 Push the dial to wake up the thermostat
- 2 Once the screen turns on, press the **Menu** (☰) button
- 3 Turn the dial to select **Heat**, then push the dial
- 4 Choose **Schedule**, then select **View/Edit Current**
- 5 Turn the dial left or right to browse through the days and to select a day
- 6 You'll now see the schedule for the day you selected.

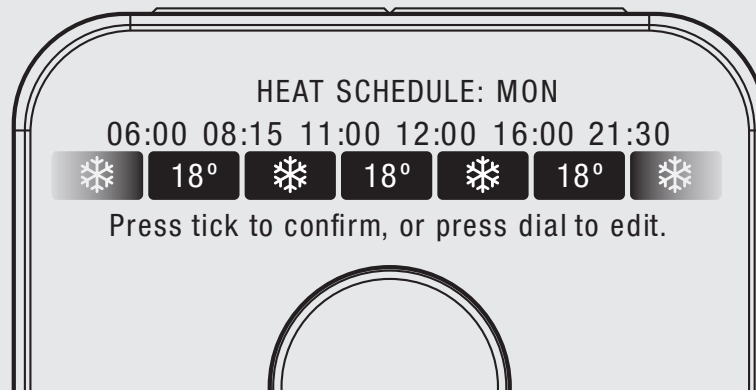

**Hot tip:** To edit the schedule for that day, just push the dial.

### How to boost your heating for a short time:

- 1 Press the **Heating Boost** (🔥) button on top of the thermostat to turn the heating on
- 2 Press the **Heating Boost** (🔥) button again to increase the length of your boost
- 3 Turn the dial to change the boost temperature (it's set to 22 °C by default)
- 4 When the boost finishes, your heating will go back to its previous mode
- 5 To cancel boost early, press the **Back** (↶) button.

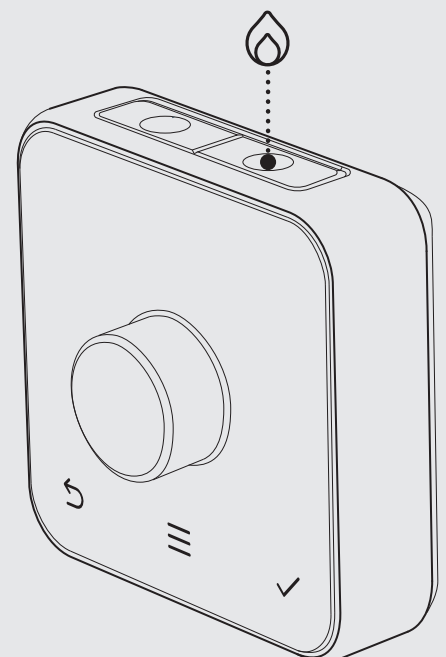



### 2 Hot water

#### How to change mode:

Hot water features are not shown on combi boilers (boilers without a separate hot water tank) as they automatically heat water when it's needed.

#### How to turn your hot water on or off:

- 1 Wake up your thermostat by pushing the dial
- 2 Once the screen turns on, press the **Menu**  button
- 3 Turn the dial to select **Hot Water**, then push the dial
- 4 Choose either **Always On** or **Always Off**
- 5 Press the **Confirm**  button.



**Hot tip:** If you only want hot water at certain times of the day, using **Schedule** mode could be more energy efficient.

### Setting up a new hot water schedule:

Your thermostat will walk you through setting up your hot water schedule step by step.

#### To do this:

- 1 Wake up your thermostat by pushing the dial and press the **Menu** ☰ button
- 2 Turn the dial to select **Hot Water** and push the dial to confirm
- 3 Select **Schedule** and push the dial to confirm
- 4 Scroll to **Start Over** and push the dial to confirm
- 5 Follow the on-screen instructions to create your new schedule.

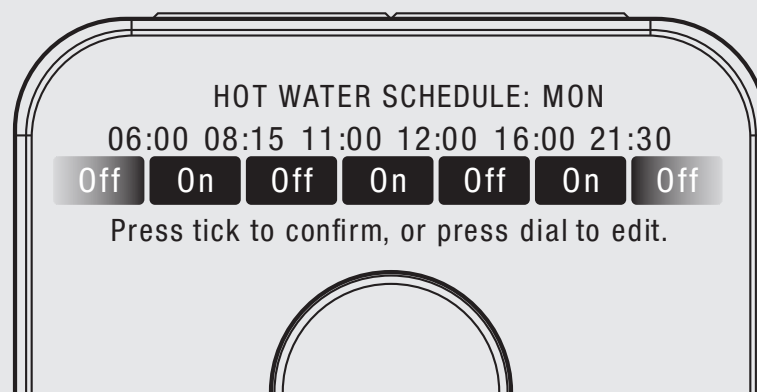

### How to view your hot water schedule:

- 1 Push the dial to wake up the thermostat
- 2 Once the screen turns on, press the **Menu** ☰ button
- 3 Turn the dial to select **Hot Water**, then push the dial
- 4 Choose **Schedule**, then select **View/Edit Current**
- 5 Turn the dial left or right to browse through the days and to select a day
- 6 You'll now see the schedule for the day you selected.



**Hot tip:** To edit the schedule for that day, push the dial to start editing.

### How to boost your hot water for a short time:

- 1 Press the **Hot Water Boost**  button on top of the thermostat to turn the hot water on
- 2 Press the **Hot Water Boost**  button again to increase the length of your boost
- 3 When your boost finishes, your system will go back to your previous mode
- 4 To cancel your boost early, press the **Back**  button.

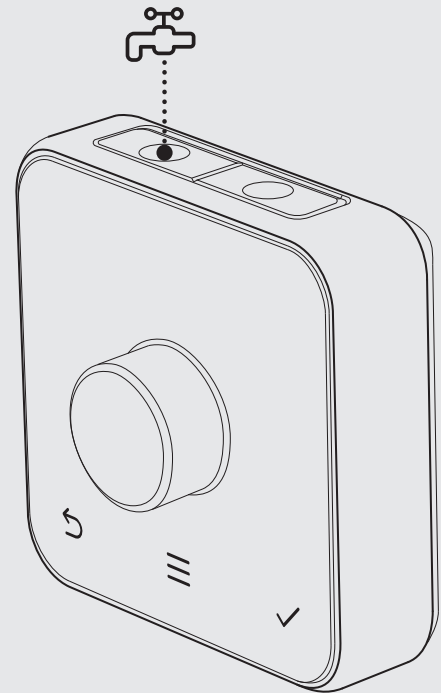

### 3 Other features

#### More things you can do with your thermostat

- Select **Holiday** mode and set the dates you'll be away by going to **Menu**, then **Holiday**
- Set a **Child Lock** so little hands can't change the temperature. Find it under **Menu** then **Settings**
- Increase the temperature of your **Frost Protection** setting. By default this is set so your home won't drop below 7 °C and will activate whatever mode your heating is in. Find it under **Menu** then **Settings**.

### 4 Hive Multizone

Multizone lets you control existing plumbed heating zones in your home. Each zone needs its own Hive Thermostat and receiver.

If you are a Hive Multizone customer, to change the zone name of each thermostat, log in to the Hive app and **Tap manage>Devices>Tap on your thermostat>rename device**.

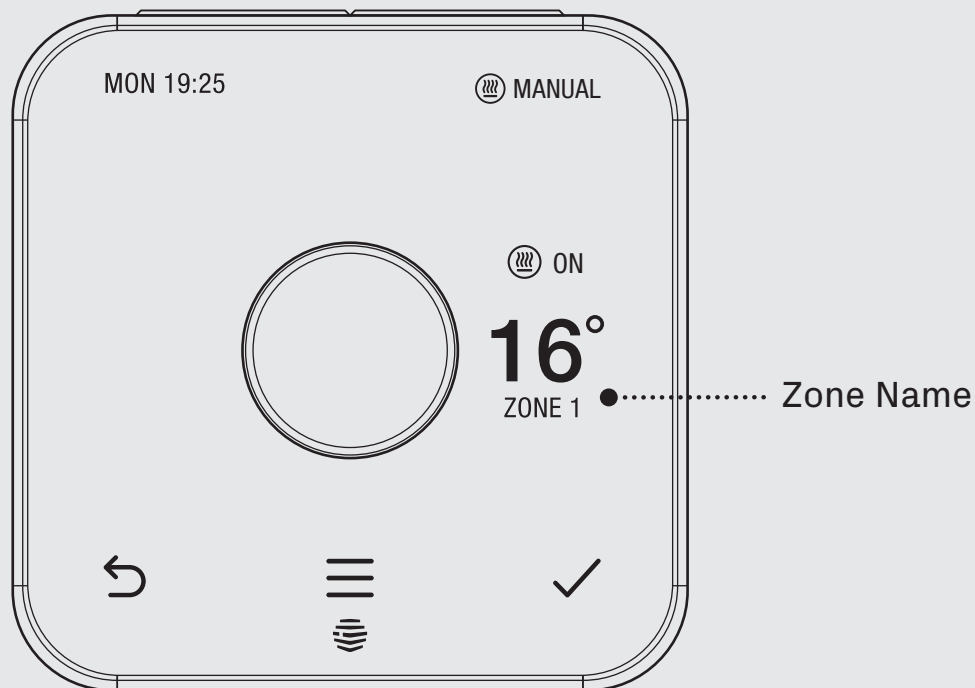

### 5 Troubleshooting

If you need to identify which of your Hive thermostats belongs to which receiver, follow these steps:

- ① Turn the heating off in every zone using the app or thermostats
- ② When you look at the receivers, the 'central heating' light should be switched off on each receiver
- ③ Turn the heating on in one zone only by using the app or thermostat. The 'central heating' light on one receiver will turn green, showing that this thermostat is paired to this receiver
- ④ Repeat these steps to identify which receivers your other thermostats are paired with.

For more information on Hive Multizone, please visit [hivehome.com/support](http://hivehome.com/support)

 A red battery symbol means your batteries need to be replaced with four new AA batteries.

#### How to change the batteries:

- ① Press the tab on the base of your thermostat
- ② Lift your thermostat off the hooks that hold it against the wall (and turn it over to access the batteries)
- ③ Simply pop the batteries out and put the new ones in
- ④ Re-hook the top of your thermostat and then press the bottom until it clicks to secure it to the wall.

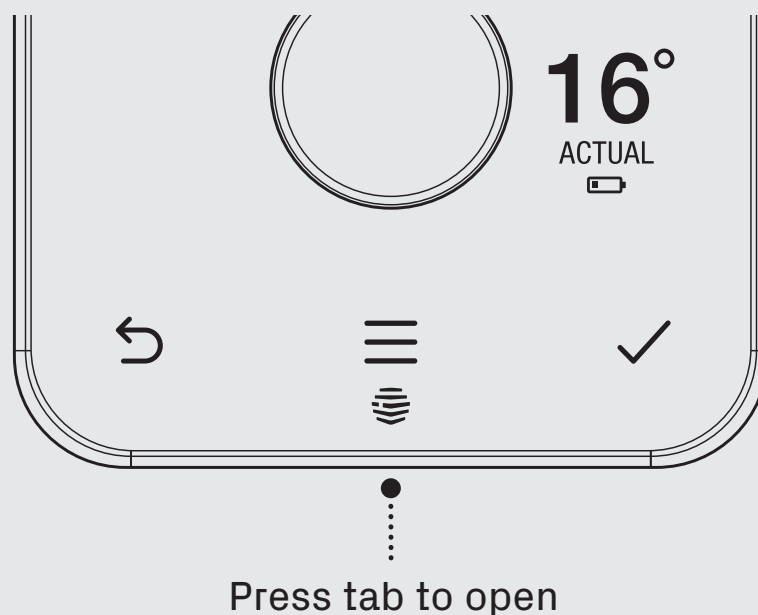

### No signal

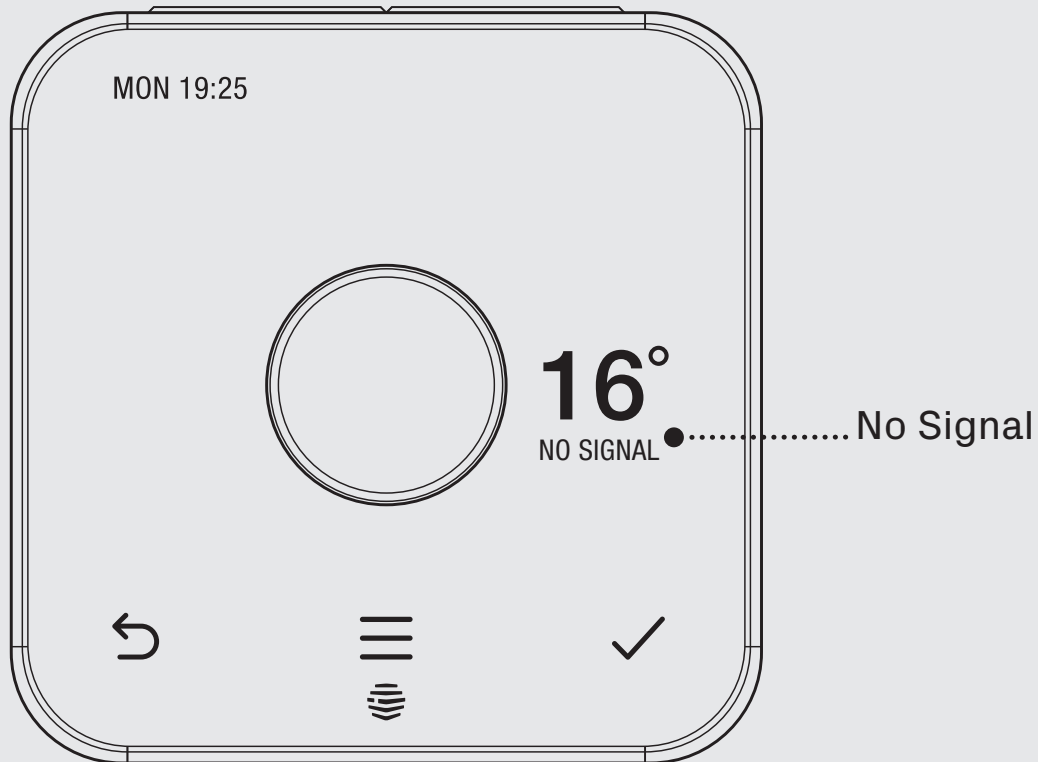

If this message shows on your thermostat, it means your thermostat and receiver aren't communicating.

For more information visit [hivehome.com/support](https://hivehome.com/support). Alternatively, you can find more advice in the Hive app.

**Hot tip:** Even without a signal you can still manually switch your heating and hot water on and off by pressing the buttons on the Hive receiver (usually beside your boiler) when its 'Status' light is red.

### Icons you might see on your thermostat

①	Current day and time	MON 19:25	⑦	Menu button	☰
②	Hot Water mode	🚿	⑧	Back button	↶
③	Heating mode	🔥	⑨	Target temperature	TARGET
④	Heating on	🔥 ON	⑩	Frost Protection	❄️
⑤	Actual temperature	ACTUAL	⑪	Boost time remaining	🚿 3:17:12
⑥	Confirm button	✓			

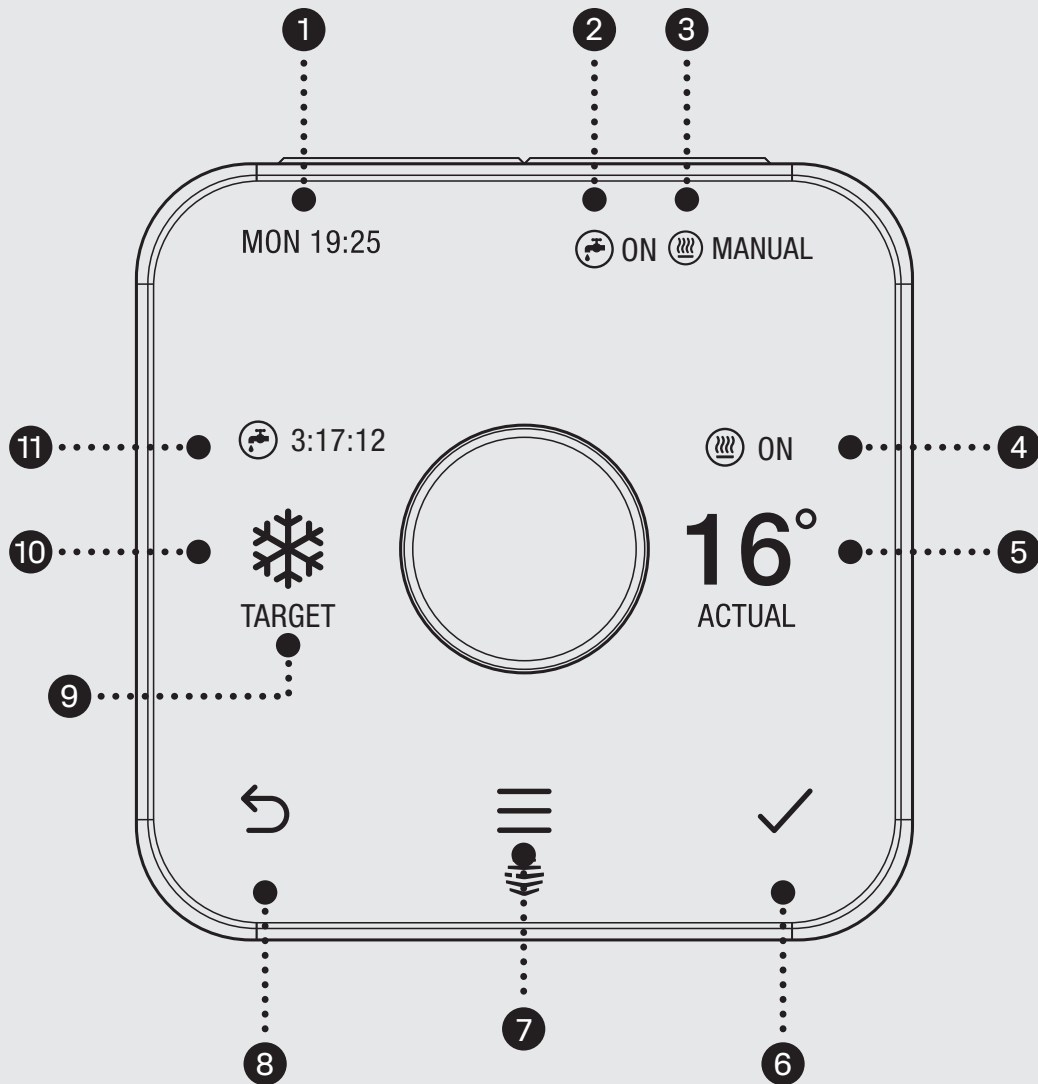

### Can we help?

You can view our handy how-to-use videos along with hints and tips at [hivehome.com/support](https://hivehome.com/support)

If for any reason you need to return your Hive Thermostat, simply return your box and its contents to the retailer. Any return is subject to the retailer's refund policy, so please don't forget to check the retailer's refund policy too.

© 2025 Centrica Hive Limited (trading as Hive).  
Registered in England (No. 5782908) SL4 5GD, UK.  
Bord Gáis Energy. Registered in Ireland (No. 463078) D02 HH27, Ireland.  
All rights, reserved.

Centrica Connected Home Limited declares that the radio equipment types SLT3c, SLR1c and SLR2c comply with UK SI 2017 No.1206 and EU Directive 201 /53/EU.

Full declaration text available at: [hivehome.com/compliance](https://hivehome.com/compliance)  
Max. radiated power: < 20 dBm. Frequency: 2400 – 2483.5 MHz

To avoid environmental and health problems due to hazardous substances in electrical and electronic goods, appliances marked with a crossed out wheeled bin should not be placed into your household rubbish bin. Instead, when they are unable to be re-used, they should be recycled. Your local authority will be able to advise you on the location of the nearest recycling centre that is authorised to accept this type of waste. Please recycle responsibly.

