



SPEAR & JACKSON

BoilerMag[®] HP

Dual Flow System Filter



Heat Pumps & Underfloor Heating



Register Your Warranty at
boilermag.com/register-warranty

Tel: +44 (0)114 225 0624



1 

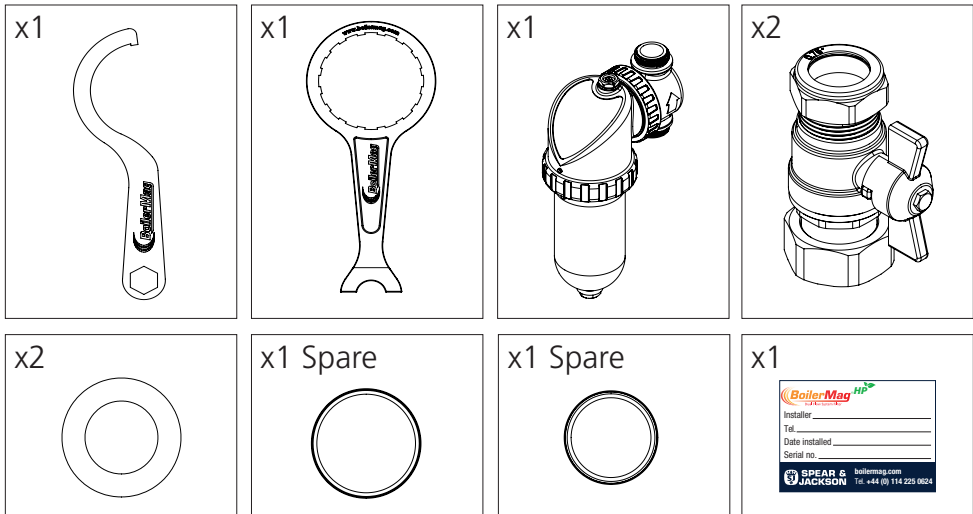

2 

Heat Pump Systems

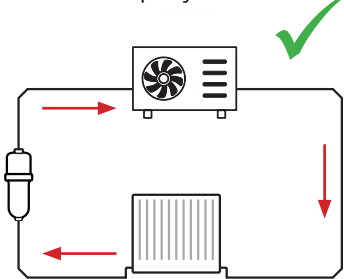

Underfloor Heating Systems

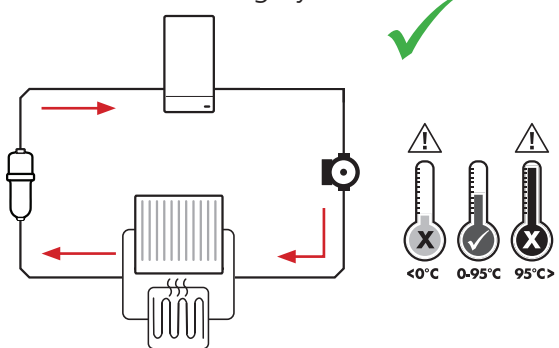

3 

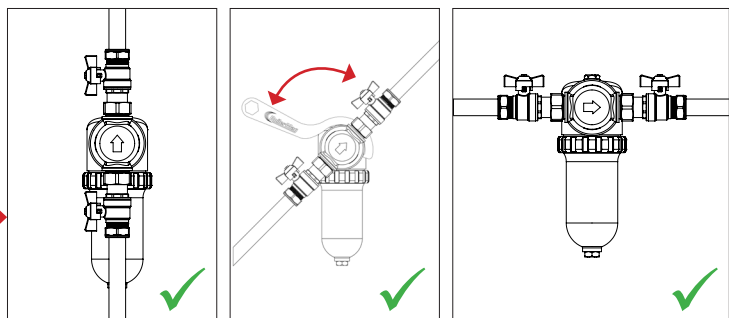
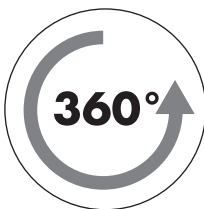

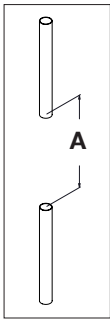

SKU	A = (mm)
BMHP28	206

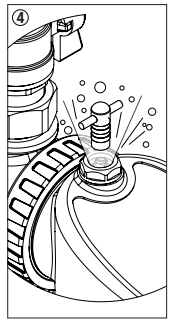
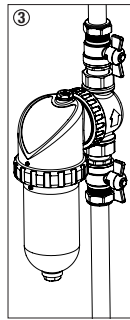
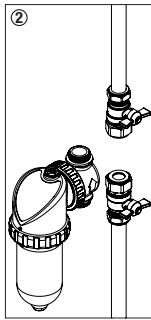
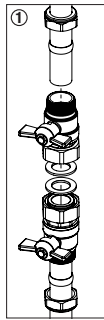

4

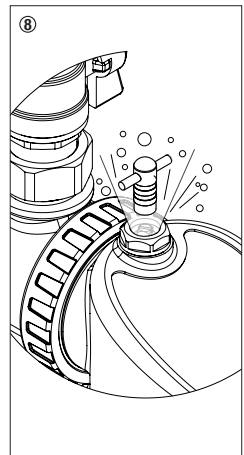
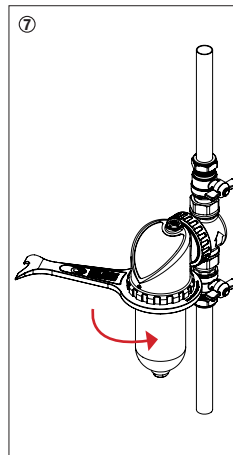
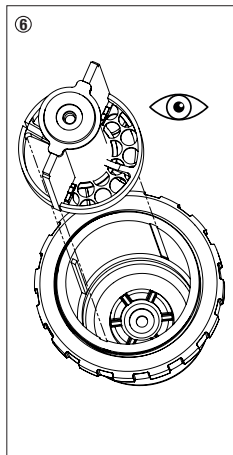
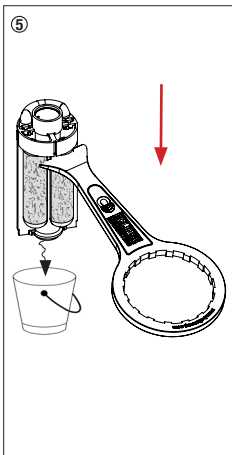
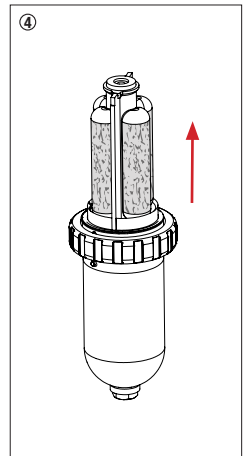
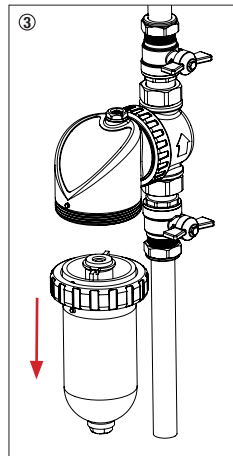
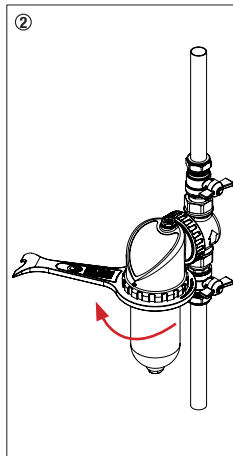
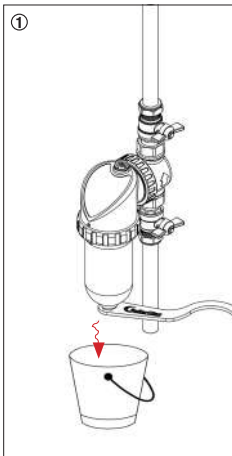

5 

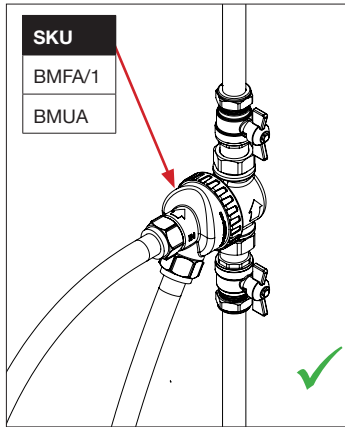
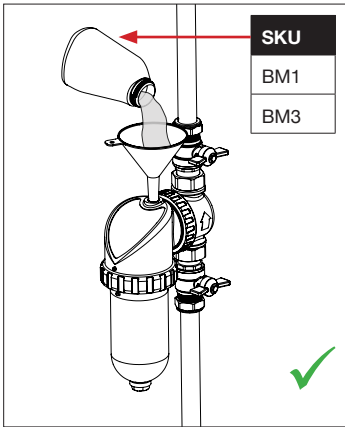

 **SPEAR & JACKSON**

BoilerMag
Dual Flow System Filter

boilermag.com

T: +44 (0)114 225 0624
service@boilermag.com



LinkedIn



 **SPEAR & JACKSON**

boilermag.com